

SMARTGUARDair Operating
instructions



CENTURION

SMART GUARD™
air



**HIGH SECURITY
KEYLESS ACCESS
CONTROL**

1. KwikLearn >>

In order to preserve battery life, the unit is packed with the link fitted on the 12V side of the power selection pins.





To select batteries as the primary power source, bridge the pin marked 'AA BATT' with the common (centre) pin.

For information on selecting 12V as the primary power source, refer to Section 19, 'Typical connection diagram'.

The following KwikLearn procedure and connection diagram will enable you to start using your **SMARTGUARDair** system right away. Additional procedures are explained later in this guide.

Add a new access code at a specified address.

The code will operate Channel 1 only.





	Indicator LEDs
Enter the following keystrokes:	
1. Enter Program Mode * Master Code ¹ *	
2. Select KwikLearn 0 #	
3. Enter user address 0 #	
4. Enter access code Code #	

¹ Default Master Code=1234

The **SMARTGUARDair** will have to be paired to a valid receiver before a code will be able to activate it. Thus, the KwikLearn procedure will store a new code in the keypad's memory, but the code will still have to be associated with a receiver using either the KwikPair facility described overleaf, or the Pairing Menu (Menu 3).

Example:

Kwiklearn access code 9 3 2 4 5 into address 2 5
Master Code= 1 2 3 4

	Indicator LEDs
Enter the following keystrokes:	
1. Enter Program Mode * 1 2 3 4 *	
2. Select KwikLearn 0 #	
3. Enter user address 2 5 #	
4. Enter access code 9 3 2 4 5 #	

2. KwikPair >>

The **SMARTGUARDair** must now be paired with a CENTURION rolling code radio receiver.

1. Place the receiver into Learn Mode, and enter a valid code on the **SMARTGUARDair**, followed by #. The **SMARTGUARDair** will now transmit for a short time, and will pair with the receiver.
2. Remove the receiver from Learn Mode, and test the system by entering a valid code, followed by #. The receiver should now activate.

3. How to use this Guide >>

The procedures in this Guide require the user to perform certain sequential actions on the **SMARTGUARDair** keypad. To assist you, the combined state of the three LED indicators on the keypad correspond with particular steps within a procedure. When carrying out the procedures, please be aware of the following:

The factory default Master Code 1 2 3 4 is used throughout this Guide as an example only. Refer to Section 7 for instructions on how to change the Master Code.

① Indicates a particular key to be pressed on the keypad by the user

☀ Indicates a lit LED

[] Indicates optional entries.

Important when choosing an access code number

If you intend using the Duress Security Parameter ensure that no consecutive numbers are assigned as codes.

Ensure that the desired code has not already been allocated

4. Icons used in this guide >>

 This icon indicates tips and other information that could be useful during the installation.

 This icon denotes variations and other aspects that should be considered during installation.

 **This icon indicates a warning, caution or attention! Please take special note of critical aspects that MUST be adhered to in order to prevent injury.**

5. General description >>

The CENTURION **SMARTGUARDair** is a durable, quality keypad designed to provide high security access control to restricted areas. The weatherproof unit is wireless, and is powered by two AA alkaline (penlight) batteries. When any key is pressed, a backlight illuminates the keypad for ease of use at night.

Access is granted by the keying in of a valid access code. The access code can vary from one to ten digits. Up to one thousand different access codes can be stored within the unit's non-volatile memory. New codes can be added and existing codes can be deleted as required. 'Token codes' can be added, allowing only a preset number of activations, after which the code becomes invalid.

Each code can activate one of fifteen channels. A channel is defined as an external CENTURION rolling code-compatible receiver, either stand-alone, single channel, multichannel or integrated into products such as the D5-Evo, D10, VECTOR2, etc.

An anti-hack feature can be enabled, causing the unit to shut down after a pre-selected number of incorrect codes have been entered. The unit will then reset after a pre-selected time. A telltale LED will indicate that the anti-hack feature has been triggered. Once programmed, the system can be backed up onto the optional Backup Memory Module (Code PCA12201V1.0). This allows the system to be easily restored if required. An optional independent tamper switch can be fitted and wired internally to transmit an alarm signal if the unit has been forced open, or removed from its mountings.

6. Technical specifications >>

Supply voltage	2 x AA Alkaline batteries or 12V DC
Operating temperature	-18°C to +55°C
Operating humidity	0 - 90% ¹
Output	Up to 15 individual channels
Housing material	Polycarbonate
Degree of protection	IP55
Battery life	two to five years ²
Code length	One to ten digits
Memory capacity	1000 unique non-volatile codes
Memory retention	>200 years
Token codes	1 - 254 activations

1. Non-condensing

2. Subject to usage

7. Changing the Master Code >>

The following procedure will enable the user to change the default Master Code **1 2 3 4** or the currently stored Master Code to a new Master Code. The Master Code may also be learned into the system by following the procedure in Section 8 'Adding a New User'.



The Master Code must always be stored at address **0**
The Master Code can be used as a normal access code

		Indicator LEDs
Enter the following keystrokes:		<input type="radio"/> <input type="radio"/> <input checked="" type="radio"/>
1. Enter Program Mode	* Master Code¹ *	<input checked="" type="radio"/> <input type="radio"/> <input type="radio"/>
2. Select KwikLearn	0 #	<input checked="" type="radio"/> <input checked="" type="radio"/> <input type="radio"/>
3. Enter address	0 #	<input checked="" type="radio"/> <input checked="" type="radio"/> <input checked="" type="radio"/>
4. Enter new code	Code #	<input type="radio"/> <input type="radio"/> <input checked="" type="radio"/>
¹ Default Master Code= 1 2 3 4		

Example: Replace the default Master Code **1 2 3 4** with a new Master Code = **3 7 8 1**

		Indicator LEDs
Enter the following keystrokes:		<input type="radio"/> <input type="radio"/> <input checked="" type="radio"/>
1. Enter Program Mode	* 1 2 3 4 *	<input checked="" type="radio"/> <input type="radio"/> <input type="radio"/>
2. Select KwikLearn	0 #	<input checked="" type="radio"/> <input checked="" type="radio"/> <input type="radio"/>
3. Enter address	0 #	<input checked="" type="radio"/> <input checked="" type="radio"/> <input checked="" type="radio"/>
4. Enter access code	3 7 8 1 #	<input type="radio"/> <input type="radio"/> <input checked="" type="radio"/>

8. Adding a new user >>

The following procedure will add a new access code at a specified address, assign which channel the code must activate and how many accesses are allowed before the code becomes invalid.

		Indicator LEDs
Enter the following keystrokes:		<input type="radio"/> <input type="radio"/> <input checked="" type="radio"/>
1. Enter Program Mode	* Master Code *	<input checked="" type="radio"/> <input type="radio"/> <input type="radio"/>
2. Select Add Menu	1 #	<input checked="" type="radio"/> <input checked="" type="radio"/> <input type="radio"/>
3. Enter user address	Address #	<input checked="" type="radio"/> <input checked="" type="radio"/> <input checked="" type="radio"/>
4. Enter access code	Code #	<input type="radio"/> <input checked="" type="radio"/> <input checked="" type="radio"/>
5. Select channel	Channel #	<input checked="" type="radio"/> <input checked="" type="radio"/> <input type="radio"/>
6. Enter access limit	[Accesses] #	<input checked="" type="radio"/> <input checked="" type="radio"/> <input type="radio"/>
7. Exit Add Menu	#	<input checked="" type="radio"/> <input type="radio"/> <input type="radio"/>
8. Exit Program Mode	#	<input type="radio"/> <input type="radio"/> <input checked="" type="radio"/>



- Repeat steps 3 - 6 for additional users
- [] denotes optional features



- If no channel is specified, Channel 1 is selected
- If the number of accesses is not specified in Step 6, unlimited access is set. Care must be taken to ensure the desired access limit is correctly applied
- If unlimited accesses are required, only enter **#** at Step 6.

Example:Add **access code 5 2 7** into **address 1 0**The code must operate **Channel 2**

Code is valid forever

Master Code= **1 2 3 4**

		Indicator LEDs		
Enter the following keystrokes:		<input type="radio"/>	<input type="radio"/>	<input checked="" type="radio"/>
1. Enter Program Mode	* 1 2 3 4 *	<input checked="" type="radio"/>	<input type="radio"/>	<input type="radio"/>
2. Select Add Menu	1 #	<input checked="" type="radio"/>	<input checked="" type="radio"/>	<input type="radio"/>
3. Enter user address	1 0 #	<input checked="" type="radio"/>	<input checked="" type="radio"/>	<input checked="" type="radio"/>
4. Enter access code	5 2 7 #	<input type="radio"/>	<input checked="" type="radio"/>	<input checked="" type="radio"/>
5. Select channel	2 #	<input checked="" type="radio"/>	<input checked="" type="radio"/>	<input type="radio"/>
6. Enter access limit	#	<input checked="" type="radio"/>	<input checked="" type="radio"/>	<input type="radio"/>
7. Exit Add Menu	#	<input checked="" type="radio"/>	<input type="radio"/>	<input type="radio"/>
8. Exit Program Mode	#	<input type="radio"/>	<input type="radio"/>	<input checked="" type="radio"/>

Example:Add **access code 9 3 5 2 3** into **address 1 0**The code must operate **Channel 5**Code is valid for **2 uses**Master Code= **1 2 3 4**

		Indicator LEDs		
Enter the following keystrokes:		<input type="radio"/>	<input type="radio"/>	<input checked="" type="radio"/>
1. Enter Program Mode	* 1 2 3 4 *	<input checked="" type="radio"/>	<input type="radio"/>	<input type="radio"/>
2. Select Add Menu	1 #	<input checked="" type="radio"/>	<input checked="" type="radio"/>	<input type="radio"/>
3. Enter user address	1 0 #	<input checked="" type="radio"/>	<input checked="" type="radio"/>	<input checked="" type="radio"/>
4. Enter access code	9 3 5 2 3 #	<input type="radio"/>	<input checked="" type="radio"/>	<input checked="" type="radio"/>
5. Select channel	5 #	<input checked="" type="radio"/>	<input checked="" type="radio"/>	<input type="radio"/>
6. Enter access limit	2 #	<input checked="" type="radio"/>	<input checked="" type="radio"/>	<input type="radio"/>
7. Exit Add Menu	#	<input checked="" type="radio"/>	<input type="radio"/>	<input type="radio"/>
8. Exit Program Mode	#	<input type="radio"/>	<input type="radio"/>	<input checked="" type="radio"/>

9. Deleting a user >>>

The following procedure will delete an access code at a specified address.

		Indicator LEDs		
Enter the following keystrokes:		<input type="radio"/>	<input type="radio"/>	<input checked="" type="radio"/>
1. Enter Program Mode	* Master Code *	<input checked="" type="radio"/>	<input type="radio"/>	<input type="radio"/>
2. Select Delete Menu	2 #	<input checked="" type="radio"/>	<input checked="" type="radio"/>	<input type="radio"/>
3. Enter user address	Address #	<input checked="" type="radio"/>	<input checked="" type="radio"/>	<input type="radio"/>
4. Exit Delete Menu	#	<input checked="" type="radio"/>	<input type="radio"/>	<input type="radio"/>
5. Exit Program Mode	#	<input type="radio"/>	<input type="radio"/>	<input checked="" type="radio"/>



- Repeat Step 3 to delete additional user codes
- If address is specified as 0, all access codes will be deleted and the Master Code will revert to the factory default,

Master Code= **1 2 3 4****Example:**Delete **access code** at **address 9 9**Master Code= **1 2 3 4**

		Indicator LEDs		
Enter the following keystrokes:		<input type="radio"/>	<input type="radio"/>	<input checked="" type="radio"/>
1. Enter Program Mode	* 1 2 3 4 *	<input checked="" type="radio"/>	<input type="radio"/>	<input type="radio"/>
2. Select Delete Menu	2 #	<input checked="" type="radio"/>	<input checked="" type="radio"/>	<input type="radio"/>
3. Enter user address	9 9 #	<input checked="" type="radio"/>	<input checked="" type="radio"/>	<input type="radio"/>
4. Exit Delete Menu	#	<input checked="" type="radio"/>	<input type="radio"/>	<input type="radio"/>
5. Exit Program Mode	#	<input type="radio"/>	<input type="radio"/>	<input checked="" type="radio"/>

Example:Delete all **access codes**. Master Code= **1 2 3 4**

		Indicator LEDs		
Enter the following keystrokes:		<input type="radio"/>	<input type="radio"/>	<input checked="" type="radio"/>
1. Enter Program Mode	* 1 2 3 4 *	<input checked="" type="radio"/>	<input type="radio"/>	<input type="radio"/>
2. Select Delete Menu	2 #	<input checked="" type="radio"/>	<input checked="" type="radio"/>	<input type="radio"/>
3. Enter user address	0 #	<input checked="" type="radio"/>	<input checked="" type="radio"/>	<input type="radio"/>
4. Exit Delete Menu	#	<input checked="" type="radio"/>	<input type="radio"/>	<input type="radio"/>
5. Exit Program Mode	#	<input type="radio"/>	<input type="radio"/>	<input checked="" type="radio"/>

Example:Delete **access code** at **addresses 5 4** and **8 7**Master Code= **1 2 3 4**

		Indicator LEDs		
Enter the following keystrokes:		<input type="radio"/>	<input type="radio"/>	<input checked="" type="radio"/>
1. Enter Program Mode	* 1 2 3 4 *	<input checked="" type="radio"/>	<input type="radio"/>	<input type="radio"/>
2. Select Delete Menu	2 #	<input checked="" type="radio"/>	<input checked="" type="radio"/>	<input type="radio"/>
3. Enter user address	5 4 #	<input checked="" type="radio"/>	<input checked="" type="radio"/>	<input type="radio"/>
4. Enter user address	8 7 #	<input checked="" type="radio"/>	<input checked="" type="radio"/>	<input type="radio"/>
5. Exit Delete Menu	#	<input checked="" type="radio"/>	<input type="radio"/>	<input type="radio"/>
6. Exit Program Mode	#	<input type="radio"/>	<input type="radio"/>	<input checked="" type="radio"/>

10. Pairing >>

A clear distinction must be made between the Pairing Menu and the Adding Menu.

The Adding Menu will be used whenever a new code is to be added to the **SMARTGUARDair**'s memory. This will in turn create a means of 'unlocking' transmission to a designated receiver; a valid code will have to be entered before the unit will begin transmitting.

Conversely, the Pairing Menu allows the user to pair the **SMARTGUARDair** to one or more CENTURION rolling code receivers within the specified range of transmission, comparable to learning a remote control into a receiver.

	Indicator LEDs
Enter the following keystrokes:	<input type="radio"/> <input type="radio"/> <input checked="" type="radio"/>
1. Enter Program Mode * Master Code *	<input checked="" type="radio"/> <input type="radio"/> <input type="radio"/>
2. Select Pairing Menu 3 #	<input checked="" type="radio"/> <input checked="" type="radio"/> <input type="radio"/>
3. Enter channel Channel #	<input checked="" type="radio"/> <input checked="" type="radio"/> <input checked="" type="radio"/>
4. Enter receiver type* 0 OR 1	<input checked="" type="radio"/> <input checked="" type="radio"/> <input type="radio"/>
5. Enter transmission time [0 - 90 seconds] #	<input checked="" type="radio"/> <input checked="" type="radio"/> <input checked="" type="radio"/>
6. Exit Pairing Menu #	<input checked="" type="radio"/> <input type="radio"/> <input type="radio"/>
7. Exit Program Mode #	<input type="radio"/> <input type="radio"/> <input checked="" type="radio"/>

* 0 for NOVA receiver

1 for future receiver

Once transmission has ended, repeat Steps 3 and 4 for additional channels.



- The maximum transmission time is 90 seconds
- If no receiver is specified, NOVA is selected by default
- The default transmission duration is eight seconds
- Additional functionality, such as pulsing or latching outputs is handled by the associated receiver

Example:

Pair **Channel 1** with a **NOVA receiver**, allowing for a transmission duration of ten seconds.

Master Code = 1 2 3 4

	Indicator LEDs
Enter the following keystrokes:	<input type="radio"/> <input type="radio"/> <input checked="" type="radio"/>
1. Enter Program Mode * 1 2 3 4 *	<input checked="" type="radio"/> <input type="radio"/> <input type="radio"/>
2. Select Pairing Menu 3 #	<input checked="" type="radio"/> <input checked="" type="radio"/> <input type="radio"/>
3. Enter channel 1 #	<input checked="" type="radio"/> <input checked="" type="radio"/> <input checked="" type="radio"/>
4. Enter receiver type 0 #	<input checked="" type="radio"/> <input checked="" type="radio"/> <input type="radio"/>
5. Enter transmission time 1 0 #	<input checked="" type="radio"/> <input checked="" type="radio"/> <input checked="" type="radio"/>
6. Exit Pairing Menu #	<input checked="" type="radio"/> <input checked="" type="radio"/> <input type="radio"/>
7. Exit Program Mode #	<input type="radio"/> <input type="radio"/> <input checked="" type="radio"/>

11. Setting the anti-hack parameters >>

The following procedure sets the number of wrong access codes that the **SMARTGUARDair** will accept before becoming inactive, as well as the time for which it will remain inactive. The factory default for wrong access codes is three, while the default reset time is 60 seconds.

	Indicator LEDs
Enter the following keystrokes:	<input type="radio"/> <input type="radio"/> <input checked="" type="radio"/>
1. Enter Program Mode * Master Code *	<input checked="" type="radio"/> <input type="radio"/> <input type="radio"/>
2. Select Lockout Menu 4 #	<input checked="" type="radio"/> <input checked="" type="radio"/> <input type="radio"/>
3. Enter number of codes Wrong codes #	<input checked="" type="radio"/> <input checked="" type="radio"/> <input checked="" type="radio"/>
4. Enter Reset Time Seconds #	<input checked="" type="radio"/> <input type="radio"/> <input type="radio"/>
5. Exit Program Mode #	<input type="radio"/> <input type="radio"/> <input checked="" type="radio"/>

Example:

Set **wrong code alarm** to activate after five incorrect codes have been entered. The unit must reactivate after 30 seconds.

Master Code = 1 2 3 4

	Indicator LEDs
Enter the following keystrokes:	<input type="radio"/> <input type="radio"/> <input checked="" type="radio"/>
1. Enter Program Mode * 1 2 3 4 *	<input checked="" type="radio"/> <input type="radio"/> <input type="radio"/>
2. Select Lockout Menu 4 #	<input checked="" type="radio"/> <input checked="" type="radio"/> <input type="radio"/>
3. Enter number of codes 5 #	<input checked="" type="radio"/> <input checked="" type="radio"/> <input checked="" type="radio"/>
4. Enter Reset Time 3 0 #	<input checked="" type="radio"/> <input type="radio"/> <input type="radio"/>
5. Exit Program Mode #	<input type="radio"/> <input type="radio"/> <input checked="" type="radio"/>

12. Setting the key wipeout time >>>

The following procedure sets the number of seconds for which keystrokes remain valid. This ensures that if a partial code has been entered, it is wiped out of the keypad buffer after a preset time, and must be re-entered in its entirety.

The clearing of the keypad buffer is indicated by the keypad's back light turning off.

The factory default for the key wipeout timer is five seconds.

	Indicator LEDs		
Enter the following keystrokes:			
1. Enter Program Mode * Master Code *			
2. Select Wipeout Menu 5 #			
3. Enter Wipeout Time [Seconds] #			
4. Exit Program Mode #			



- If the Wipeout time is set to **0**, key wipeout will be disabled (only applicable to externally powered devices)



Disabling the key wipeout time will:

- Compromise the security of the system
- Cause a code entry to be incorrectly recognised as a wrong code if an incomplete code was previously entered

Example:

Set the key wipeout time to 15 seconds.

Master Code= **1 2 3 4**

	Indicator LEDs		
Enter the following keystrokes:			
1. Enter Program Mode * 1 2 3 4 *			
2. Select Wipeout Menu 5 #			
3. Enter Wipeout Time 1 5 #			
4. Exit Program Mode #			

Example:

Disable key wipeout time.

Master Code= **1 2 3 4**

	Indicator LEDs		
Enter the following keystrokes:			
1. Enter Program Mode * 1 2 3 4 *			
2. Select Wipeout Menu 5 #			
3. Enter Wipeout Time 0 #			
4. Exit Program Mode #			

13. Setting the security parameters >>>

The following procedure sets the conditions under which the Alarm channel (Channel 3) will activate. This also sets the anti-default and tone mute features.

The following alarm conditions can be set:

Duress (Code + 1)(Default=off)

Adding **1** to the last digit of an access code activates the unit as normal, but also activates the alarm channel. This is used if entering under duress. E.g. If the access code is **1 2 3 4**, entering **1 2 3 5** gives access, but also activates the alarm

Alarm (* + #)(Default=off)

Pressing the ***** and **#** keys simultaneously activates the Alarm channel.

Wrong Codes (Default=off)

When the number of wrong codes is exceeded, the Alarm channel is activated.

Anti-default feature (Default=on)

Setting this feature prevents the system parameters from being reset by the defaulting features.

The Master Code can still be defaulted to **1 2 3 4**, but doing this will break the pairing between the **SMARTGUARDair** and any paired receivers. This pairing will need to be re-established in order to continue using the system.

Alarm Tone Mute Feature (Default=off)

Setting this feature turns off the audible feedback when entering a code. This prevents an eavesdropper from determining the number of digits in the code. Tones will still be present in Programming Mode.

	Indicator LEDs		
Enter the following keystrokes:			
1. Enter Program Mode * Master Code *			
2. Select Security Menu 6 #			
3. Set (Code+1) 0 OR 1 #			
4. Set (*+#) 0 OR 1 #			
5. Set (Wrong Codes) 0 OR 1 #			
6. Set Anti-default 0 OR 1 #			
7. Set Tone Mute 0 OR 1 #			
8. Exit Program Mode #			



- **0 #** turns function off, **1 #** turns function on

Example:Enable Alarm on Code + **1**. Clear all other functionsMaster Code = **1 2 3 4**

	Indicator LEDs		
Enter the following keystrokes:	<input type="radio"/>	<input type="radio"/>	<input checked="" type="radio"/>
1. Enter Program Mode * 1 2 3 4 *	<input checked="" type="radio"/>	<input type="radio"/>	<input type="radio"/>
2. Select Security Menu 6 #	<input checked="" type="radio"/>	<input checked="" type="radio"/>	<input type="radio"/>
3. Set (Code+1) 1 #	<input checked="" type="radio"/>	<input checked="" type="radio"/>	<input checked="" type="radio"/>
4. Clear (*+#) 0 #	<input type="radio"/>	<input checked="" type="radio"/>	<input checked="" type="radio"/>
5. Clear (Wrong Codes) 0 #	<input type="radio"/>	<input type="radio"/>	<input checked="" type="radio"/>
6. Clear Anti-default 0 #	<input type="radio"/>	<input type="radio"/>	<input type="radio"/>
7. Clear Tone Mute 0 #	<input checked="" type="radio"/>	<input type="radio"/>	<input type="radio"/>
8. Exit Program Mode #	<input type="radio"/>	<input type="radio"/>	<input checked="" type="radio"/>

Example:

Set Alarm on Wrong Codes. Leave all other functions unchanged.

Master Code = **1 2 3 4**

	Indicator LEDs		
Enter the following keystrokes:	<input type="radio"/>	<input type="radio"/>	<input checked="" type="radio"/>
1. Enter Program Mode * 1 2 3 4 *	<input checked="" type="radio"/>	<input type="radio"/>	<input type="radio"/>
2. Select Security Menu 6 #	<input checked="" type="radio"/>	<input checked="" type="radio"/>	<input type="radio"/>
3. Skip (Code+1) #	<input checked="" type="radio"/>	<input checked="" type="radio"/>	<input checked="" type="radio"/>
4. Skip (*+#) #	<input type="radio"/>	<input checked="" type="radio"/>	<input checked="" type="radio"/>
5. Set (Wrong Codes) 1 #	<input type="radio"/>	<input type="radio"/>	<input checked="" type="radio"/>
6. Skip Anti-default #	<input type="radio"/>	<input type="radio"/>	<input type="radio"/>
7. Set Tone Mute #	<input checked="" type="radio"/>	<input type="radio"/>	<input type="radio"/>
8. Exit Program Mode #	<input type="radio"/>	<input type="radio"/>	<input checked="" type="radio"/>

14. Backing up the unit >>>

Back up all the user access codes as well as system settings to the optional PCA12201v1.0 Backup Memory Module.

This allows the system to be easily restored in the unlikely event of system failure.

Procedure for backing up the unit:

Remove power. Plug the PCA12201v1.0 into the socket provided. Reapply power. All three LEDs will now be ON. Enter ***** Master Code *****, then press **1** on the keypad.

The green LED will begin to flash, indicating that the memory is being backed up. When the backup is complete, a beep will be heard, and the yellow and green LEDs will turn off. Remove the Backup Memory Module and keep it in a safe place.



- Backing up to a Backup Memory Module will overwrite any information that was previously contained in that Backup Memory Module

15. Restoring the unit >>>

Restores all the user access codes as well as system settings from the optional PCA12201v1.0 Backup Memory Module.

Procedure for restoring the unit:

Remove power. Plug the PCA12201v1.0 into the socket provided. Reapply power. All three LEDs will now be ON. Enter ***** Master Code *****, then press **3** on the keypad. The yellow LED will begin to flash, indicating that the memory is being restored. When the memory has been restored, a beep will be heard, and the yellow and green LEDs will turn off. Remove the Backup Memory Module and keep it in a safe place.



- Restoring from a Backup Memory Module will overwrite any information that was previously contained in the SMARTGUARDair unit

16. Defaulting the unit >>>

Both the Master Code and the system parameters (timers, alarm functions, etc.) can be reset to Factory Defaults.

This is useful when the Master Code has been forgotten or the system parameters are in an unknown state.

Defaulting the Master Code:

Remove power. Reapply power while holding the **1** key down for two seconds. A beep will then follow, indicating that the Master Code has been reset to **1 2 3 4**. If the anti-default option has been enabled, the pairing between the receiver will be broken during this process. The pairing will have to be re-established before the system becomes functional.

Defaulting the System Parameters:

Remove power. Reapply power while holding the **2** and **3** keys down together for two seconds. A beep will then follow, indicating that the System Parameters have been reset to the following Factory Defaults:

Wrong Codes: three codes

Wrong Codes Reset: 60 seconds

Wipeout Timer: 5 seconds

Security Parameters: Anti-default ON, all others OFF

Defaulting is not possible if the anti-default option has been set (see Section 13).



In this case, if the Master Code has been lost, the Master Code must be defaulted back to **1 2 3 4**, which will break the pairing between the **SMARTGUARDair** and all paired receivers. This pairing will need to be re-established in order to continue using the system.

17. Typical mounting instructions: >>

1. Remove retaining screw cover and screws.
2. Insert screwdriver blade into groove provided between the cover and back panel. Lever screwdriver forward to separate the cover from the back panel.

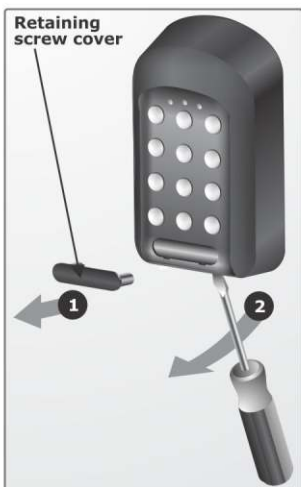

3. Fix the self-adhesive rubber pads into the recesses provided on the rear panel.
4. Attach the rear pane to the mounting surface or gooseneck with the mounting screws supplied.



Be sure to seal all the mountings with silicone sealant.



Use only the mounting holes shown. If the other mounting holes are used, the mounting screws will interfere with the batteries.

18. Fitting the anti-tamper switch >>



- If the onboard terminals are used to connect the anti-tamper switch, the switch's normally-closed (N/C) and common connections **MUST** be used. Normally-closed (N/C) will be connected to In1 and COM to Neg (-)
- If the anti-tamper switch is to be connected to a third-party alarm system, either normally-closed or normally-open can be used, along with a common connection

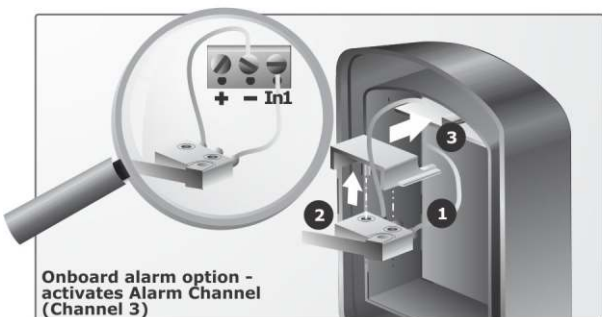

OR

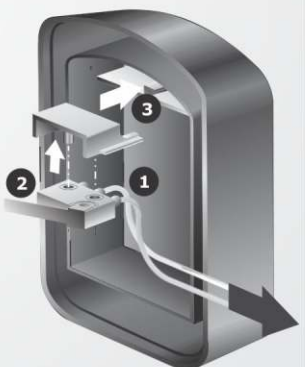

19. Typical connection diagram >>

Refer to this diagram only if an external 12V power source is to be used* Even though an external power supply will provide a more or less unlimited duty cycle, there will be no autonomy whatsoever in the event of a power failure.



* Should an external 12V power supply be used, the power selection link must be moved to bridge the pin marked '12 Volt' with the common (centre) pin.

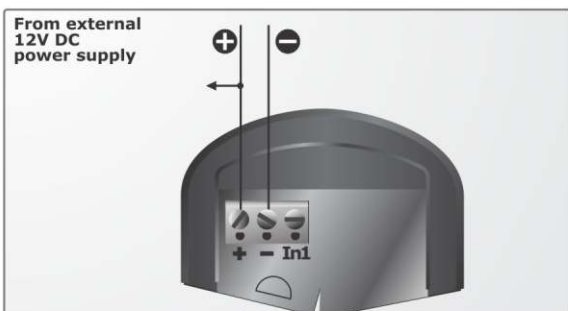

The supply voltage should not exceed 12V DC

20. Glossary of terms >>

Access code

The code number the user will enter to gain access. It can range in length from one to ten digits.

Address/ User address

The location where the user's code is stored in the keypad memory. It can be any number between 1 and 999.

It should be recorded, allowing the user code to be removed from the memory later if necessary.

Master Code

The code number required for programming the keypad. It is stored in user address 0.



- The default Master Code of a new unit **1 2 3 4**
- For security reasons, the installer should change this code at the time of installation.
Refer to Section 7 for instructions on how to change the Master Code.

Enter key

In order to gain access, the user code must be followed by a #.

21. Important installation information >>

Complete the installation information below for future reference.



Keep this manual in a safe place.

Master Code

Channel 1 activates

Channel 2 activates

Channel 3 activates

Channel 4 activates

Channel 5 activates

Channel 6 activates

Channel 7 activates

Channel 8 activates

Channel 9 activates

Channel 10 activates

Channel 11 activates

Channel 12 activates

Channel 13 activates

Channel 14 activates

Channel 15 activates

Installers information:

Name:

Mobile number:

Email address:

Physical address:

For your convenience you will find an Address Register included in your **SMARTGUARDair** packaging. Use this Address Register to record which addresses have been assigned, their access code and which channel will be activated by that address.



Keep the address register in a safe place!

The supplied Address Register will record the first **500** addresses, from **0 to 499**. Should you require a second Address Register to record the next **500** address, i.e. address **500 to 999**, please contact your nearest CENTURION SYSTEMS branch or distributor.



A large area of horizontal dashed lines for recording information, with a small square icon at the bottom right corner.



Sharecall 0860-CENTURION (0860 236 887)
Head Office: +27 11 699 2400

Sharecall Technical Support 0861 003 123 or
+27 11 699 2481
from 07h00 to 18h00 (GMT+2)

(Sharecall numbers applicable when dialed from within South Africa only)



0.07.A.0108_22072013

www.centsys.com